

I give permission for public access to my Honors paper and for any copying or digitization to be done at the discretion of the College Archivist and/or the College Librarian.

John Larkin Musgrove, Jr.

May 20th, 2010

Regulated expression of the *SccA* gene by the inducible *AlcA*
promoter affects both development and cell wall integrity in
Aspergillus nidulans

John Larkin Musgrove, Jr.

Department of Biochemistry and Molecular Biology
Rhodes College
Memphis, Tennessee

2010

Submitted in partial fulfillment of the requirements for the
Bachelor of Science degree with Honors in Biochemistry and
Molecular Biology

This Honors paper by John Larkin Musgrove, Jr. has been read and approved for Honors in the Department of Biochemistry and Molecular Biology.

Dr. Darlene Loprete

Dr. Terry Hill

Dr. Laura Luque de Johnson

ACKNOWLEDGEMENTS

This research project was made possible by the generous support of the Department of Biochemistry and Molecular Biology at Rhodes College. Specifically the guidance and input offered by Dr. Terry Hill, Dr. Darlene Loprete, Dr. Loretta Jackson-Hayes and Dr. Sara Gremillion was critical to the success of this work. Also, this paper benefitted from the critical review of Dr. Laura Luque de Johnson. Finally, the progress of this work was aided by Erinn Ogburn, Mohammad Atiq, Rachel Hickey, Laura Johnson, and Jackie Ward – all of whom helped to conduct experiments, discuss ideas and provide critical insight.

TABLE OF CONTENTS

Introduction	1
Materials and Methods	10
Results	16
Discussion	24
References	29

FIGURES & TABLES

Figure 1. PkcA::GFP localization	3
Figure 2. Fungal membrane receptor structure	3
Figure 3. Cell wall integrity pathway of <i>S. cerevisiae</i>	5
Figure 4. SccA::GFP localization	5
Figure 5. The ethanol utilization pathway of <i>A. nidulans</i>	7
Figure 6. pGEM [®] + <i>AlcA^P</i> + <i>AfPyrG</i> vector	12
Figure 7. Insertion of <i>AlcA^P</i> + <i>AfPyrG</i> cassette	12
Table 1. Primers used in this study	15
Figure 8. Comparison of 512bp and 733bp <i>AlcA^P</i> strains	17
Figure 9. Effect of carbon source concentration on vegetative growth	19
Figure 10. Effect of <i>Scca</i> repression and derepression on CFW sensitivity	20
Figure 11. Effect of <i>SccA</i> induction on CFW sensitivity	21

Figure 12. Osmotic remediation of sporulation defect	23
Figure 13. Effect of <i>PkcA</i> repression in <i>Aspergillus nidulans</i>	25

ABSTRACT

Regulated expression of the *SccA* gene by the inducible *AlcA* promoter affects both development and cell wall integrity in *Aspergillus nidulans*

by

John Larkin Musgrove, Jr.

This research describes a novel gene designated *SccA*, which affects cell wall integrity in *A. nidulans*. Plasmid-borne extra copies of *SccA* can suppress the phenotype of the *calC2* mutation in the *A. nidulans* orthologue of protein kinase C (PkcA), which results in hypersensitivity to the chitin-binding agent Calcofluor White (CFW). In filamentous fungi, as in yeasts, hypersensitivity to CFW correlates with defects in cell wall integrity. The hypothetical translated product of *SccA* is a 271-aa protein (unprocessed), with a probable transmembrane domain and an extracellular domain rich in serine and threonine. A *SccA*-GFP hybrid localizes to the plasma membrane of vegetative hyphae. When *SccA* is placed under the tightly regulatable *AlcA* promoter, vegetative growth is normal under both de-repressive and repressive conditions (growth on glycerol and glucose containing medium, respectively), but asexual sporulation is inhibited during growth on glycerol. This defect in sporulation is osmotically remediable by supplementing either medium with 0.6 M KCl. *SccA* repression increases CFW sensitivity, while *SccA* induction decreases sensitivity. We hypothesize that this phenotype is representative of a signal transduction protein functioning in the cell wall integrity pathway.

INTRODUCTION

The filamentous fungus *Aspergillus nidulans* is the most genetically tractable member of the *Aspergillus* genus, which includes species of industrial, agricultural and medical significance (Yu et al. 2006). *Aspergillus fumigatus* infection in immunocompromised patients leads to invasive aspergillosis, which is often life threatening (Latgé 1999). For several decades, amphotericin B, which associates with ergosterols in the cell membrane, has remained the primary treatment for invasive aspergillosis despite an acute toxicity which limits therapeutic efficacy (Ostrosky-Zeichner et al. 2003, Wingard et al. 2000). Furthermore, patients who are able to tolerate this toxicity often show poor response rates ranging from 30-55% (Florl et al. 1998). Often, accurate clinical diagnosis of invasive aspergillosis is not made, and the mortality rate of patients not receiving treatment within ten days of clinical manifestation approaches 90% (Denning 2000). In recent years, the incidence of *A. fumigatus* infection has risen, and the prevalence of immunocompromising disease will only exacerbate this pathogenic threat (Latgé 2001). In fact, more than a decade ago, invasive aspergillosis became the leading cause of infectious death for patients receiving allogenic bone marrow transplants (Wald et al. 1997). Thus, a broader knowledge of the biochemical and molecular processes that regulate *Aspergillus* structure, growth and development will be a vital component of the research needed to discover novel anti-fungal medications to combat this pathogen.

A vital structural component of fungal cells is the fungal cell wall, which is absent in animal cells. This difference is clinically significant, as fungal cell wall metabolism represents a prime target for potential anti-fungal therapies (Maertens &

Boogaerts 2000). This essential organelle is composed of a complex assembly of cross-linked polysaccharides and glycoproteins which define the shape of the fungal cell (Lesage and Bussey 2006). The rigid structure of the cell wall is responsible for resisting outward turgor pressure and for mediating a complex variety of interactions between fungal cells and their environment. However, the intricate architecture and metabolism of the cell wall is incompletely understood, and a better understanding of the processes required for maintaining this structure should reveal a wealth of knowledge concerning fungal growth and development.

A technique used to identify novel genes required in cell wall metabolism of *Saccharomyces cerevisiae* is to screen cells for hypersensitivity to wall compromising agents such as the chitin binding agent Calcofluor White (CFW) (Ram et al 1994, Lussier et al 1997, Carnero et al. 2000). Furthermore, as demonstrated by Hill et al. (2006), this technique can be successfully employed to isolate cell wall mutants in *Aspergillus nidulans*. One strain, designated *calC2*, exhibits CFW hypersensitivity and has been complemented by the *A. nidulans* orthologue of protein kinase C (*PkcA*) (Teepe et al. 2007). This observation provided the first evidence that *PkcA* plays an integral role in the maintenance of cell wall integrity of *Aspergillus nidulans* (Teepe et al. 2007). This conclusion was reinforced by the observations that a *Pkc::GFP* chimera localizes to hyphal apices and actively forming septa during polarized cell growth. It was also demonstrated that this protein localizes to the apices of phialides, which are responsible for asexual sporulation (Teepe et al. 2007) (**Figure 1**).

In addition to the *PkcA* complementation of *calC2*, a high copy extragenic suppressor of the *calC2* mutation was also isolated. The DNA sequence of this suppressor

Figure 1. PkcA::GFP localization

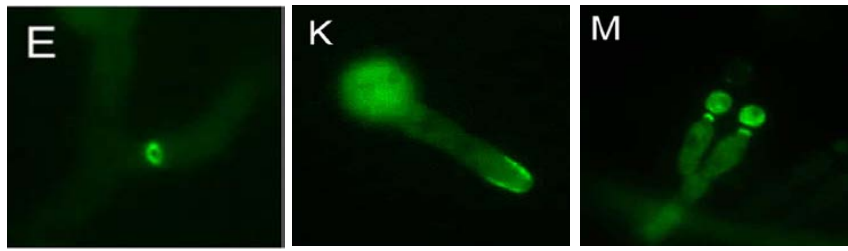

Visualization of PkcA::GFP chimeras. PkcA localizes to actively forming septa (E), localizes to hyphal apices during polarized cell growth (K), and localizes to conidiogenous apices of phialides essential for asexual sporulation (M). (Adapted from Teepe et al. 2006)

Figure 2. Fungal membrane receptor structure

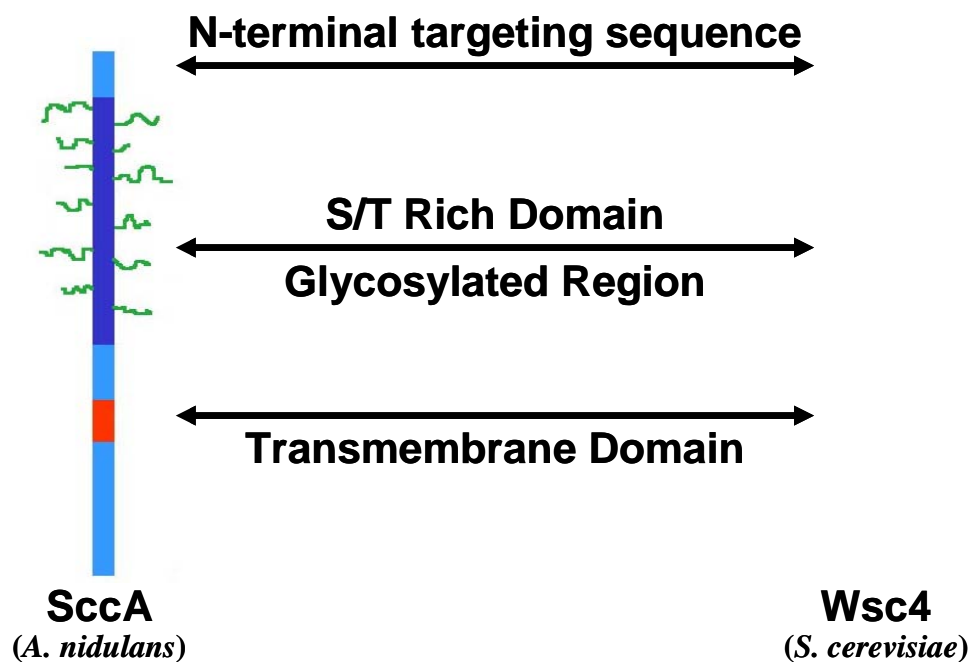

Comparison of predicted *A. nidulans* SccA protein structure to a possible functional homologue Wsc from *S. cerevisiae*. The proteins are predicted to function in the cell wall integrity pathways of *A. nidulans* and *S. cerevisiae* respectively. (Wsc diagram adapted from Verna et al. 1997).

corresponded to the uncharacterized ORF AN4897 in the Broad Institute *Aspergillus* genome database. Since plasmid-borne extra copies of AN4897 under its native promoter suppress the *calC2* phenotype, AN4897 was designated *SccA* for suppressor of *calC2* mutation (Hill, Loprete and Jackson-Hayes, unpublished data). The *SccA* gene is composed of an 816bp nucleotide sequence, predicted to encode a 271 amino acid transmembrane protein possessing no conserved domains. Its predicted structure includes a cleavable N-terminal ER-targeting sequence, an internal membrane anchor, and an exoplasmic serine/threonine rich domain (**Figure 2**). The presence of a serine/threonine domain, which is targeted by *O*-mannosyltransferases for the addition of *O*-mannosyl glycans in the endoplasmic reticulum, suggests that *SccA* is heavily *O*-glycosylated (Strahl-Bolsinger et al. 1999). Recently, it has been demonstrated that *O*-mannosylation of transmembrane receptor proteins is essential for sensing environmental stress, maintaining protein stability and coordinating proper localization (Kriangkripipat and Momany 2009). Thus, the serine/threonine rich domain in the predicted structure of *SccA* suggests that this transmembrane protein could function as a mechanosensor in *A. nidulans*. In the presence of wall compromising agents such as CFW, mechanosensor deficiencies can impede cell wall integrity signaling which can lead to insufficient activation of the proteins that mediate the cellular response to such stress (Levin 2005). A diagram of the cell wall integrity pathway in *S. cerevisiae* is provided in **Figure 3**.

A BLAST query revealed that the only orthologues of *SccA* are hypothetical proteins within filamentous fungal genomes. However, since the predicted structure of *SccA* contains features common to fungal mechanosensors, it is possible that this protein functions in a manner similar to the membrane sensors Mid2 and Mtl1, which are involved in the cell wall integrity pathway of *Saccharomyces cerevisiae* (Levin 2005). As

Figure 3. Cell wall integrity pathway of *S. cerevisiae*

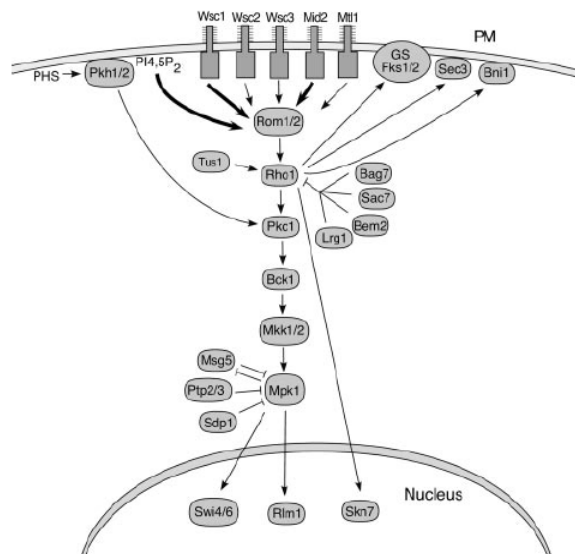

Wall stress signals are mediated by cell surface sensors (Wsc, Mid, and Mtl) which activate Rho1 (G-protein), stimulating Pkc1 (*S. cerevisiae* orthologue of protein kinase C). Pkc1 initiates a MAP kinase cascade which targets transcription factors in the nucleus (Adopted from Levin 2005).

Figure 4. SccA::GFP localization

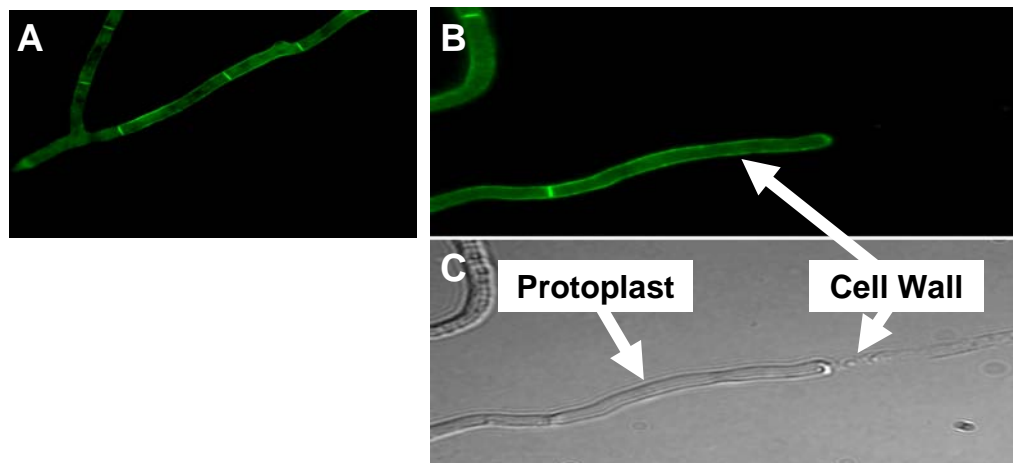

Visualization of SccA::GFP chimeras. SccA localizes to mature septa (not actively forming septa) (A), localizes to mature septum and along cell wall (B). Outline of the protoplast in plasmolyzed cell for reference (C) (Hill, unpublished data).

described by Verna et al. (1997), the *Wsc* genes in *S. cerevisiae* are predicted to encode transmembrane proteins with N-terminal targeting sequences and serine/threonine rich domains (**Figure 2**). Moreover, these proteins are predicted to be involved in the stress signaling of the *S. cerevisiae* cell wall integrity pathway (Verna et al. 1997). Thus, the similarities in the predicted structure and function of *SccA* and the well characterized *Mid2*, *MtI1*, and *Wsc* proteins could indicate that functional homologues of *SccA* exist in *S. cerevisiae*.

SccA localization during *A. nidulans* development was observed by creating a *SccA::GFP* chimera, which localized to the plasma membrane and to mature septa (Loprete and Hill, unpublished data) (**Figure 4**). Attempts to create *SccA* knockout strains for phenotypic analysis have so far been unsuccessful. To circumvent this problem, the highly inducible *A. nidulans AlcA* promoter (*AlcA^P*) was used to establish a conditional gene expression system capable of controlled expression of *SccA in vivo* (Adams and Timberlake 1990, Mirabito et al. 1989, Waring et al. 1989).

In wild type fungi, the *AlcA^P* drives the expression of the alcohol dehydrogenase I gene, which in combination with aldehyde dehydrogenase, form the ethanol utilization pathway (Felenbok 1991). The induction of this pathway is mediated by the *AlcR* positive transcriptional regulator, whose only physiological co-inducer is acetaldehyde (Flipphi et al. 2002). The catabolism of primary alcohols (ethanol), primary monoamines (ethylamine), and amino acids such as L-threonine share acetaldehyde as a common metabolic intermediate, and each of these compounds strongly induces the *AlcR* regulon (Flipphi et al. 2002, Kulmburg et al. 1992) (**Figure 5A**).

In the presence of a good carbon source such as glucose, the *CreA* transcription factor concomitantly blocks both the *AlcR* regulon and the *AlcA^P*, resulting in strong

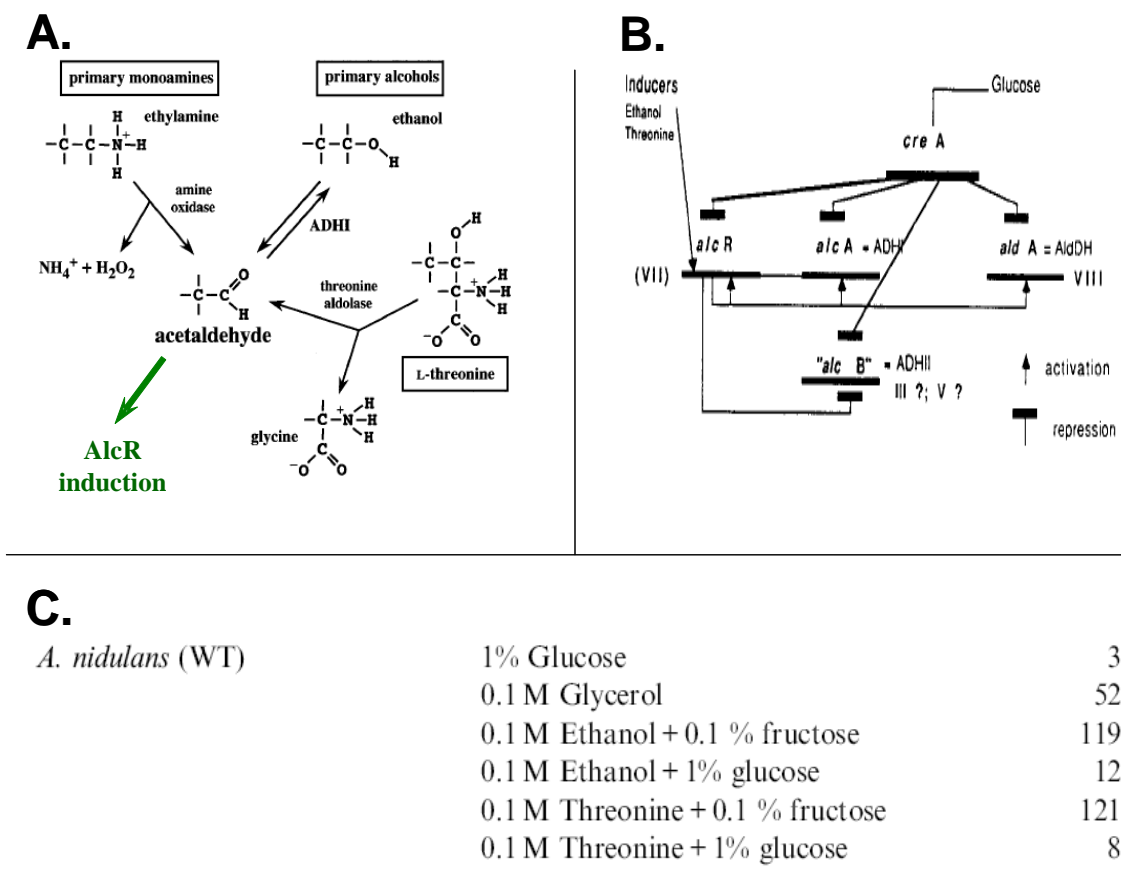
Figure 5. The ethanol utilization pathway of *A. nidulans*

(A) The catabolism of primary monoamines, primary alcohols and L-threonine each yields acetaldehyde, which is the sole physiological inducer of the AlcR regulon (adapted from Flippi et al. 2002). (B) The ethanol utilization pathway. AlcR mediates induction of *AlcA* and *AldA* expression in the presence of co-inducers (EtOH & L-threonine). Repression of these genes is mediated by the CreA transcription factor in the presence of glucose (adapted from Felenbok 1991). (C) Regulation of alcohol dehydrogenase activity in *A. nidulans* under various growth conditions. Alcohol dehydrogenase activity measured in U/mg protein (adapted from Romero et al. 2003).

repression of the ethanol utilization pathway (Adams and Timberlake 1990, Felenbok 1991). However, in the absence of glucose, poor carbon sources (glycerol, lactose, and fructose) facilitate basal expression levels, which are mediated by a balance between CreA repression and AlcR induction (Fillinger et al. 1995). Thus, the variation in *AlcA^P*-driven expression, mediated by the environmentally responsive CreA and AlcR factors, provides an excellent system for selectively expressing a gene of interest. A diagram of the ethanol utilization transcription regulation system is provided in **Figure 5B**.

Replacing the native *SccA* promoter with the *AlcA^P* enabled us to determine the effects of *SccA* induction, derepression and repression on fungal development in the presence of CFW. Furthermore, glucose-mediated repression in this selective gene expression system is commonly employed to verify genes essential to growth and development in *A. nidulans* (Felenbok et al. 2001, Adams et al. 1988). We observed that the strong repression of *SccA* did not appear to produce any morphological defects, which suggests that the leaky expression driven by the *AlcA^P* under these conditions meets cellular requirements. However, this observation contradicts the fact that *SccA* knockouts have not been successfully produced. Further investigation will be required to determine the level of *SccA* expression permitted by glucose-mediated repression and the level of *SccA* expression that satisfies the minimal cellular requirement.

In the present study, a glycerol medium was used to produce *AlcA^P* derepression, providing a basal level of *SccA* expression (Fillinger et al. 1995). *SccA* overexpression was achieved by supplementing growth media with a strong *AlcA^P* inducer L-threonine, or with an equimolar ratio of L-threonine and glycerol (Flipphi et al 2002). A table of alcohol dehydrogenase activities under various growth conditions is provided in **Figure 5C**. Finally, a glucose medium was used to produce *SccA* repression (Adams and

Timberlake 1990, Felenbok 1991). On these various media, *AlcA^P+SccA* strains were grown in the presence of CFW to determine the phenotype associated with each level of *SccA* expression. The conclusion that this predicted mechanosensor is involved in the activation of the fungal cell wall integrity pathway is supported by the observation that *SccA* repression impedes morphological development in the presence of CFW.

MATERIALS AND METHODS

A. nidulans strain and Plasmids – *Aspergillus nidulans* strain A1145 (*pyrG89*; *pyroA4*; *nkuA::argB*; *riboB2*) was the wild type strain used in this work. As described in Nayak et al. (2005), the deletion of the *nkuAΔ* gene reduces the frequency of nonhomologous integration during transformation, creating an efficient host for genomewide gene-targeting. Plasmid pFNO3 (FGSC) was used for cloning the *Aspergillus fumigatus* *PyrG* gene (*AfPyrG*), as a fungal selectable marker (Yang et al. 2004). The *AlcA^P* was amplified from A1145 genomic DNA (Marhoul 1995). The plasmid pGEM[®]-5Zf(+) (Promega, Madison, WI) was employed to construct the *AlcA^P – AfPyrG* cassette. The plasmid PBLUESCRIPT II SK⁺ (Stratagene, Wilmington, DE) was used in the construction of the *AlcA^P* probe in Southern blots.

Cloning of the AlcA^P – AfPyrG Cassette – The high-fidelity *Pfu* DNA polymerase (Promega) was employed in all PCRs performed to clone the *AlcA^P – AfPyrG* cassette. The *AlcA^P – AfPyrG* cassette was constructed in two steps. First, primers *AlcA* 5' (containing a *SpeI* site) and *AlcA* 3' (containing a *NotI* site) were used to amplify a 733bp *AlcA^P* sequence from A1145 genomic DNA. The PCR product was purified with the Qiagen PCR purification kit (Qiagen Inc., Valencia, CA) and digested with *NotI* and *SpeI* for 1hr., and gel purified using the Qiagen QIAquick[®] gel extraction kit. This cleaned PCR product was ligated into the pGEM[®]-5Zf(+) plasmid using the Quick Ligation[™] kit (New England Biolabs Inc., Ipswich, MA) (Nayak 2006). Second, primers *AfPyrG* 5' (containing a *SpeI* site) and *AfPyrG* 3' (containing a *NcoI* site) were used to amplify the *AfPyrG* selective marker from the pFNO3 plasmid. The PCR product was purified with the Qiagen PCR purification kit, digested for 1hr., and gel purified with

the QIAquick[®] gel extraction kit. The cleaned PCR product was treated with calf intestinal phosphatase (New England Biolabs) for 1hr., and then heat inactivated at 65°C. The resulting cleaned, dephosphorylated PCR product was ligated into the pGEM[®] vector upstream from the *AlcA^P* and inverted (3' → 5') to prevent read-through. The primers used in this study are listed in **Table 1**. A diagram of the pGEM[®]+*AlcA^P*+*AfPyrG* vector is provided in **Figure 6**.

SccA promoter replacement – A 781bp sequence upstream from the *SccA* gene was PCR amplified from A1145 genomic DNA with primers *SccA*-P1 and *SccA*-P3. Then an 850bp sequence of the *SccA* gene was amplified with primers *SccA*-P4 and *SccA*-P4. The *AlcA^P*-*AfPyrG* cassette was amplified with *AlcA*-*AfPyrG* cassette 5' and *AlcA*-*AfPyrG* cassette 3'. PCR products were purified with the QIAquick[®] gel extraction kit. The PCR products were mixed in a molar ratio of 2:3 (vector to insert) in a 50µl fusion PCR reaction containing the *SccA* nested 5' and *SccA* nested 3' primers and the Phusion[®] high-fidelity polymerase (New England BioLabs Inc.). The fusion PCR reaction was carried out according to the manufacturer guidelines. The linear fusion product was gel purified with the QIAquick[®] kit and transformed into strain A1145 by protoplasting as described previously (Yelton et al. 1983; Szewczyk et al. 2007). A diagram of the *AlcA^P* insertion upstream of the *SccA* start codon is provided in **Figure 7**.

Media and growth conditions – Strains were grown on complete medium (CM) consisting of 1% glucose, 0.2% peptone, 0.1% yeast extract, 0.1% casamino acids, 5% nitrate salts, 1% trace elements, 0.1% vitamin mix, 1.2 mM L-arginine, 10 mM uracil and

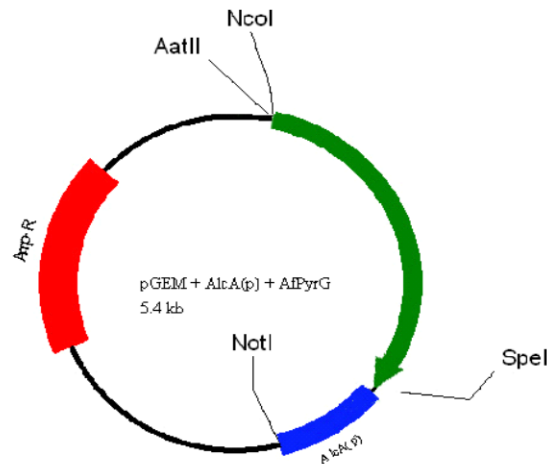
Figure 6. pGEM[®]+*AlcA*^P+*AfPyrG* vector

pGEM[®] plasmid was used to create an *AlcA*^P+*AfPyrG* cassette. The cloned vector was then digested with *Nco*I and *Spe*I to provide copies of the cassette for fusion PCR.

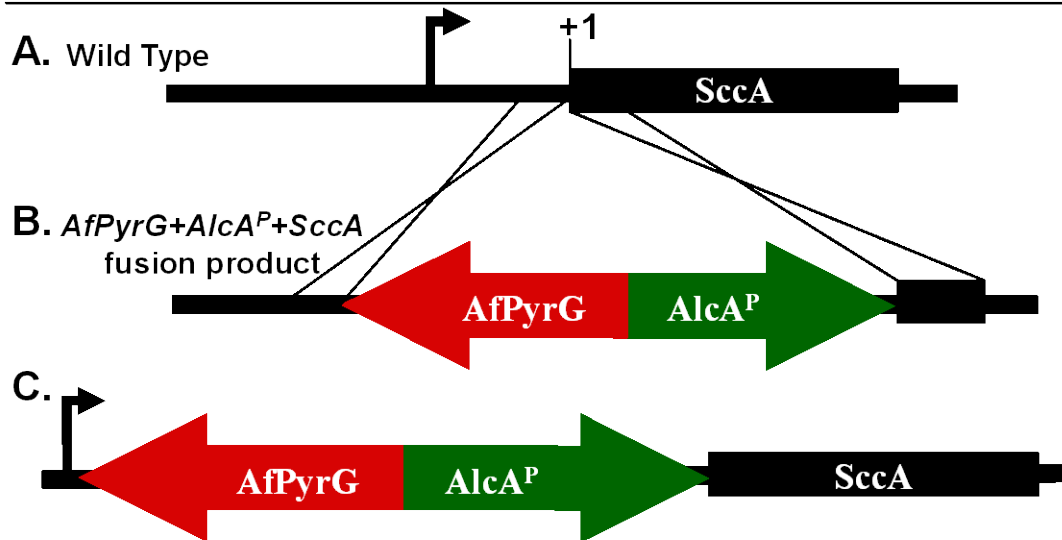
Figure 7. Insertion of *AfPyrG*+*AlcA*^P cassette

Fusion PCR was used to join the *AlcA*^P+*AfPyrG* cassette to upstream and downstream sequences on either side of the *SccA* start codon. **(A)** Linear diagram of the wild type *SccA* gene. **(B)** *AfPyrG*+*AlcA*^P+*SccA* fusion product which allowed for the insertion of the *AfPyrG*+*AlcA*^P cassette upstream of the *SccA* start codon via homologous recombination. **(C)** Linear diagram of the native *SccA* promoter displacement in *AlcA*^P+*SccA* strains.

5 mM uridine. Vitamin mix and nitrate salts are described in the appendix of Kafer (1977). Trace element solution is described in Hill & Kafer (2001). Minimal medium (MM) consisted of 1% glucose, 5% nitrate salts, 1% trace elements, 0.001% thiamine hydrochloride and 25 ng biotin ml⁻¹. To regulate the expression of the *AlcA^P* in *AlcA^P+SccA* strains, MM was supplemented with the following carbon sources: 1% glucose (repression), 1% glycerol (derepression), 100 mM threonine (induction), and 100 mM threonine + 100 mM glycerol (induction). The effect of increased osmotic strength was investigated using media supplemented with 0.6 M KCl. Solid media contained 1.5% agar and 50 mg ampicillin ml⁻¹. All cultures were incubated at either 30°C or 42°C.

DNA Extraction – Strains were grown on CM agar until heavy sporulation occurred. Spores were then harvested and used to inoculate a 50 mL volume of CM liquid media. Strains were grown for approximately 18 hr., 30°C, 130 rpm. Mycelium was harvested, and frozen in liquid nitrogen before being ground with a mortar and pestle. 10 mL of Lysis buffer (0.5 M NaCl, 10mM Tris-HCl, pH 7.4, 10 mM EDTA, 1% SDS) and 10 mL of phenol:chloroform:isoamyl alcohol were added to the ground mycelium. The mixture was then centrifuged at 10, 000 X g for 10 min. at 4°C. The aqueous layer was retained, 100 µl of RNase (10 mg/mL) was added, and the mixture was heated to 37°C for 30 min. 10 mL of chloroform was added, and the mixture was centrifuged at 10,000 X g for 10 min. The aqueous layer was retained, 10 mL of isopropanol was added, and the centrifugation was repeated. DNA pellet was washed with 70% EtOH and resuspended in TE buffer after all traces of EtOH had been removed. A second method of extracting genomic DNA was also employed using a micro-pestle device and the same freeze/fracture DNA isolation protocol.

Screening for CFW hypersensitivity – Transformants were screened for hypersensitivity to Calcofluor White (CFW—“Blankophor BBH”—gift of Bayer Corp., Rock Hill, South Carolina) using inoculations of equal spore density, where 5 μ l of freshly harvested spores (2,000 spore/mL) were plated onto media containing the following amounts of CFW: 0.00 μ g/mL, 0.25 μ g/mL, 0.50 μ g/mL, 0.60 μ g/mL, 1.00 μ g/mL (CFW stock was 1% in 25 mM KOH, filter-sterilized and stored frozen. Stock was added to melted medium at 55°C). Cultures were incubated 3 d at 30°C or 42°C, and colony diameters were compared to those of the same strains grown in the absence of CFW, as well as to wild type strain A1145 under identical conditions.

Confirmation of *AlcA^P+SccA* insertion – Transformation of A1145 wild type DNA with the *AlcA^P+AfPyrG* cassette was confirmed by PCR. DNA was isolated from each *AlcA^P+SccA* strain using the micro-pestle technique and was added to a 50 mL PCR reaction mixture containing *Taq* DNA polymerase (New England Biolabs), the *SccA* 5' primer and the *SccA* 3' primer. 2 mL of each PCR product was added to 3 mL of water and 1 mL of loading dye. These samples were loaded onto a 0.8% agarose gel containing ethidium bromide and were visualized over UV light.

TABLE 1. Primers used in this study

Primer	Sequence ^a	Use
Cloning primers		
<i>AlcA</i> 5'	ATA <u>ACTAGT</u> TCTGCGATCGTCCATAACC	
<i>AlcA</i> 3'	ATAGCGGCCGCTTTGAGAGCGAGGTGATAGGA	
<i>AfPyrG</i> 5'	AT <u>ACCATGGA</u> ACCGGTCGCCTCAAACA	
<i>AfPyrG</i> 3'	ATA <u>ACTAGT</u> TCTGTCTGAGAGGAGGCACTGA	
<i>AlcA/PyrG Cassette</i> 5'	CTGTCTGAGAGGAGGCACTGA	Amplification of <i>AlcA^P</i> /PyrG Cassette
<i>AlcA/PyrG Cassette</i> 3'	TTTGAGAGCGAGGTGATAGGA	
<i>AlcA/SccA</i> primers		
<i>SccA</i> P1 (forward)	TGGAGTCATGAACCATGGC	Amplification of upstream fusion piece
<i>SccA</i> P3 (reverse)	TCAGTGCCTCCTCTCAGACAGGATGGGCTATTCGATGTTGC	
<i>SccA</i> P4 (forward)	CCTATCACCTCGCTCAAAATGCGGGTCACTGCTCTC	Amplification of downstream fusion piece
<i>SccA</i> P6 (reverse)	CACGATCTCTGATCCTGGC	
<i>SccA</i> nested (forward)	CCATTCAAGTAACGCCGAGT	Completed fusion piece primers
<i>SccA</i> nested (reverse)	CGAGCTAGATGAGTACCTGTGACC	
PCR verification primers		
<i>SccA</i> 5'	GGGACCGAGACCTGTATCATC	
<i>SccA</i> 3'	CTGGCTCATGAAGAAGAATATGC	
<i>AlcA</i> probe primers		
<i>AlcA</i> probe 5'	ATAGGATCCACACAACATATTTTCGTCAGACACAG	
<i>AlcA</i> probe 3'	ATACTGCAGGAGGCGAGGTGATAGGATTG	

^a Underlined sequence corresponds to the indicated restriction site.

RESULTS

Characterization of $AlcA^P$ – Previously, a 512bp $AlcA^P$ sequence was used to regulate the expression of *SccA*. However, under glucose mediated repression, half of these 512bp $AlcA^P+SccA$ strains exhibited an increase in CFW sensitivity while the other strains exhibited a resistance to CFW which surpassed the WT strain (see **Figure 8A** strains R-838, R-839, R-840 and R-841). These observations prevented the determination of a single phenotype associated with *SccA* repression. Furthermore, we hypothesized that this variance in phenotype could be due in part to the fact that the 512bp version of the $AlcA^P$ might not include all of the elements of the $AlcA^P$ system, such as the entire *AlcR* regulator.

Thus, a 733bp $AlcA^P$ sequence that was employed by Nayak et al. (2006) to regulate the expression of the *A. nidulans md2A* gene was used in this study to replace the shorter version of this promoter. Roughly 10 of these 733bp $AlcA^P+SccA$ strains were generated, four of which were selected as a representative phenotypic group. The two $AlcA^P+SccA$ strains are compared in **Figure 8A, 8B**. Although one of the 733bp $AlcA^P+SccA$ strains (SccA-4) exhibited the ultra-resistant CFW phenotype, the remaining strains demonstrated an enhanced sensitivity to CFW under glucose mediated repression. These strains, in addition to the two strains that previously showed the same phenotype, suggest that an increase in CFW hypersensitivity under *SccA* repression is the most accurate phenotype.

Vegetative growth of $AlcA^P+SccA$ strains – The rate of *A. nidulans* vegetative growth is directly related to the rate of nutrient acquisition and the metabolic utilization of many biologically significant elements – especially carbon and nitrogen. Specifically, the

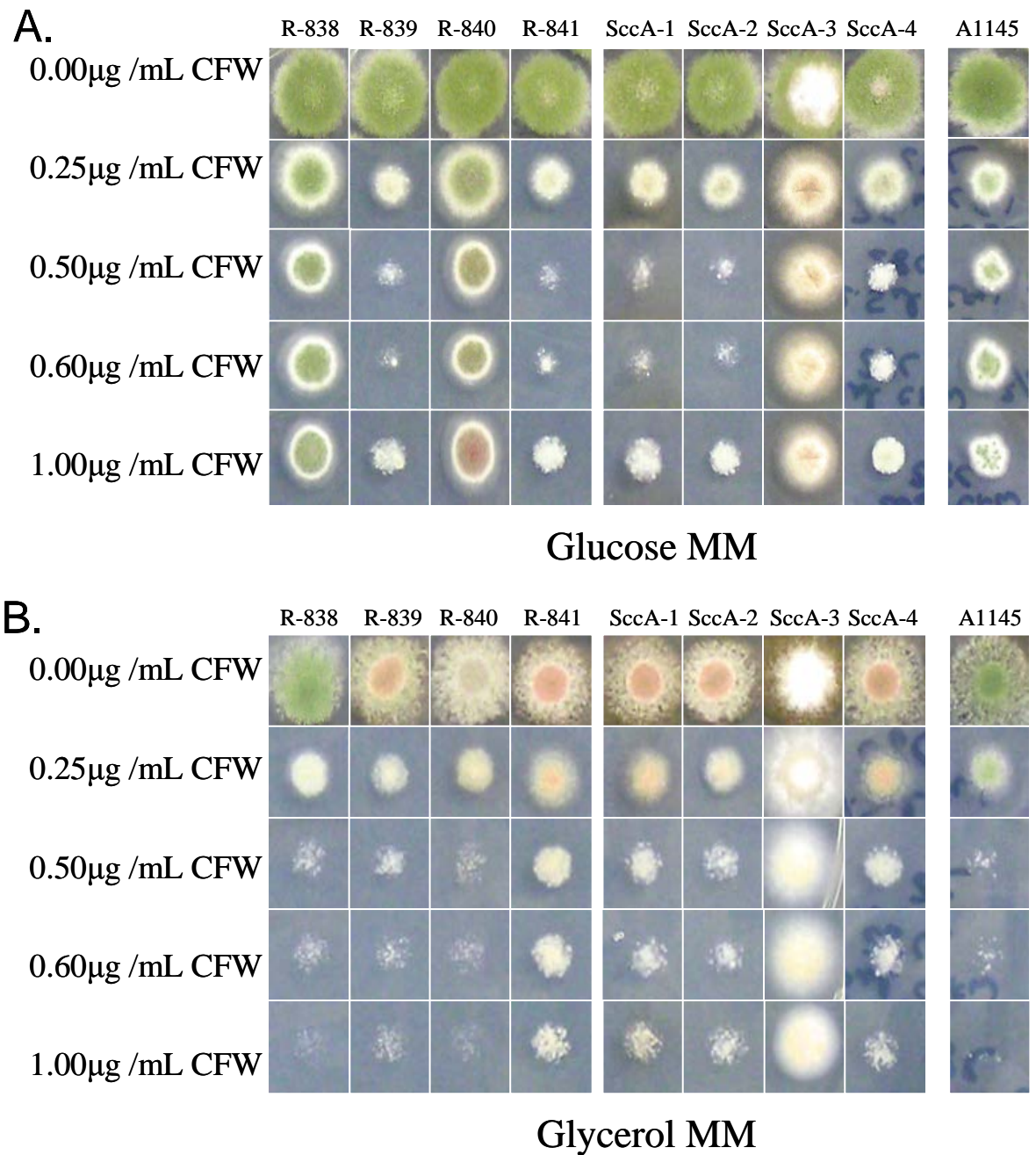
Figure 8. Comparison of 512bp and 733bp *AlcA^P* strains

Comparison between the phenotypes of the 512bp *AlcA^P*+*SccA* strains (R-838 to R-841) and the 733bp *AlcA^P*+*SccA* strains (SccA-1 to SccA-4). **(A)** On the glucose medium, half of the 512bp *AlcA^P* strains are severely affected CFW, while the other half are ultra-resistant. The 733bp *AlcA^P* strains demonstrate a consistent phenotype on glucose, with the exception of the SccA-3 strain. **(B)** The glycerol medium does not elicit a difference in the two strains with the exception of the SccA-3 outlier. Colonies were grown for 3 days @ 30°C. Each drop represents ca. 10,000 spores in 5 μ L.

alcohol compounds (ethanol, glycerol, threonine, etc.) that regulate the *AlcA^P* are metabolized less efficiently than glucose, which slows vegetative growth and produces smaller colonies.

During the phenotypic analysis of the *AlcAP+SccA* strains, we attempted to ‘normalize’ or offset this difference in vegetative growth. Strains were grown on MM supplemented with a 2X concentration of glucose and glycerol (2% w/v glucose, 2% w/v glycerol) to ensure that the uptake of carbon remained constant. However, the rate of vegetative growth was unaltered and the change in CFW sensitivity was identical to that of the *AlcAP+SccA* strains grown on 1% glucose or 1% glycerol MM (**Figure 9**).

Calcofluor White tests – The 733bp *AlcA^P+SccA* strains generated in this study were grown on derepressing (glycerol), repressing (glucose) and inducing (threonine) media to determine the phenotype associated with each level of expression in the presence of CFW. Repression of *SccA* expression under the *AlcA^P* increased sensitivity to CFW at 30°C when compared to wild-type *A1145* strain (**Figure 10**). However, strains grown on the same media at 42° C produced colonies with severe morphological defects, inhibition of sporulation and otherwise erratic phenotypic characteristics. Thus, subsequent CFW levels tests were carried out exclusively at 30° C. Derepression of *SccA* expression under the *AlcA^P* reduced sensitivity CFW in strains grown at 30° C relative to the wild-type *A1145* strain (**Figure 10**). On a purely inducing medium (100 mM L-threonine supplemented with 0.5 µg/mL CFW), vegetative growth did not appear to be significantly different from that seen on the derepressive glycerol medium with the same concentration of CFW. However, the medium containing 100 mM L-threonine and 100 mM glycerol produced vegetative growth in the presence of 0.50 µg/mL CFW (**Figure 11**).

Figure 9. Effect of carbon source concentration on vegetative growth

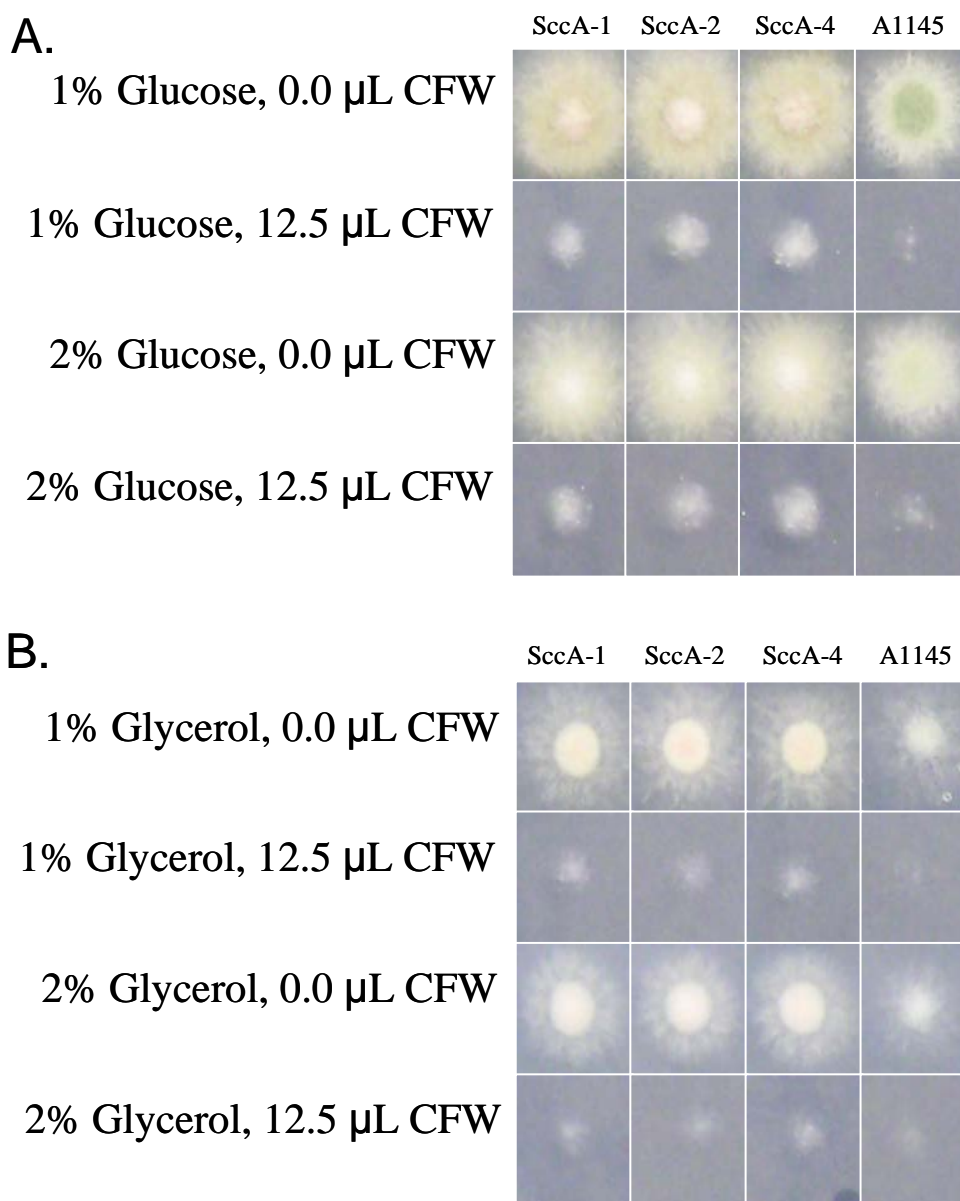

(A) Doubling the concentration of glucose in the repressing media does not affect the extent of vegetative growth or enhance CFW sensitivity, relative to the 1% glucose medium. (B) Doubling the concentration of glycerol in the derepressing media also does not affect the extent of vegetative growth or decrease CFW sensitivity. Colonies were grown for 3 days @ 30°C. Each drop represents ca. 10,000 spores in 5 μ L.

Figure 10. Effect of *Sc*cA repression and derepression on CFW sensitivity

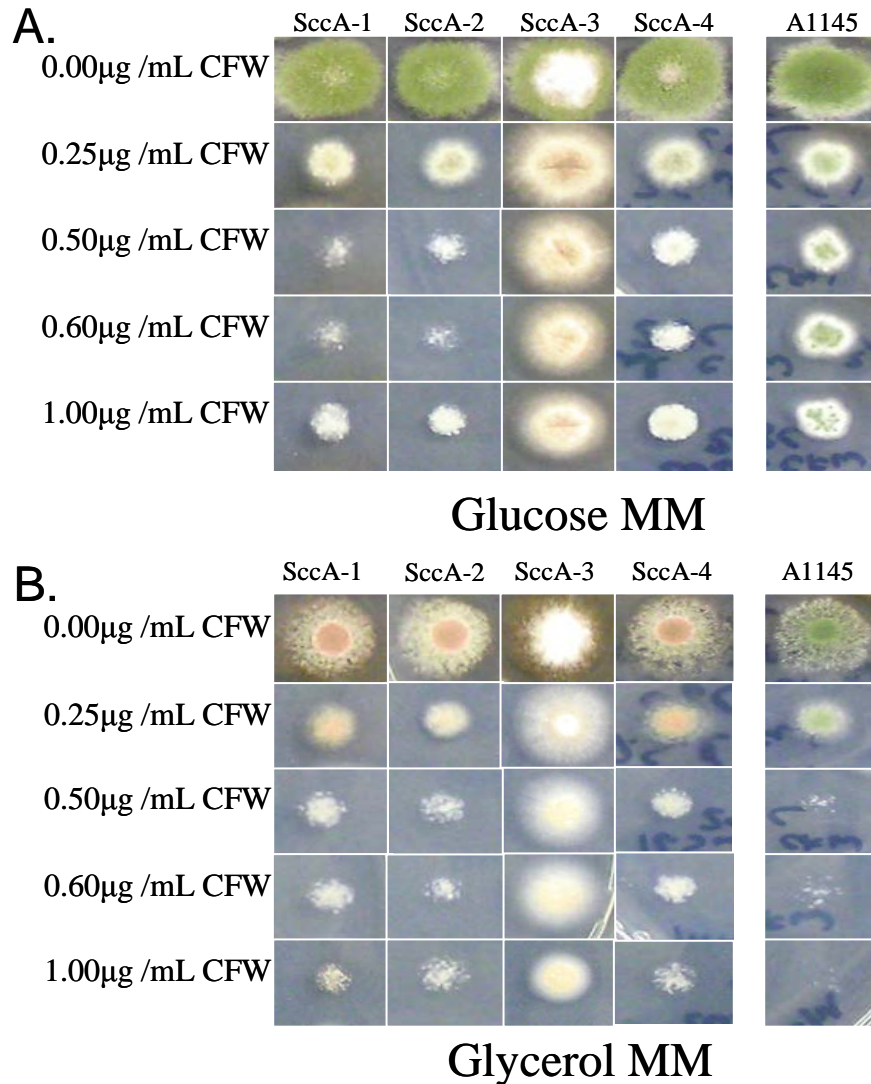

(A) The observation that *Sc*cA repression enhances CFW sensitivity is demonstrated most clearly in strains 1 and 2. Vegetative growth did slightly increase with 1.00 μ g /mL CFW on this and other tests. (B) Derepression of *Sc*cA expression consistently produced a phenotype that was characterized by a decrease in CFW sensitivity. The difference in the growth of the WT strain on the two media was attributed to the fact that glycerol is a poor carbon source. The red colonies observed when the *Sc*cA strains are grown on glycerol is indicative of an inhibition of asexual sporulation. Colonies were grown for 3 days @ 30°C. Each drop represents ca. 10,000 spores in 5 μ L.

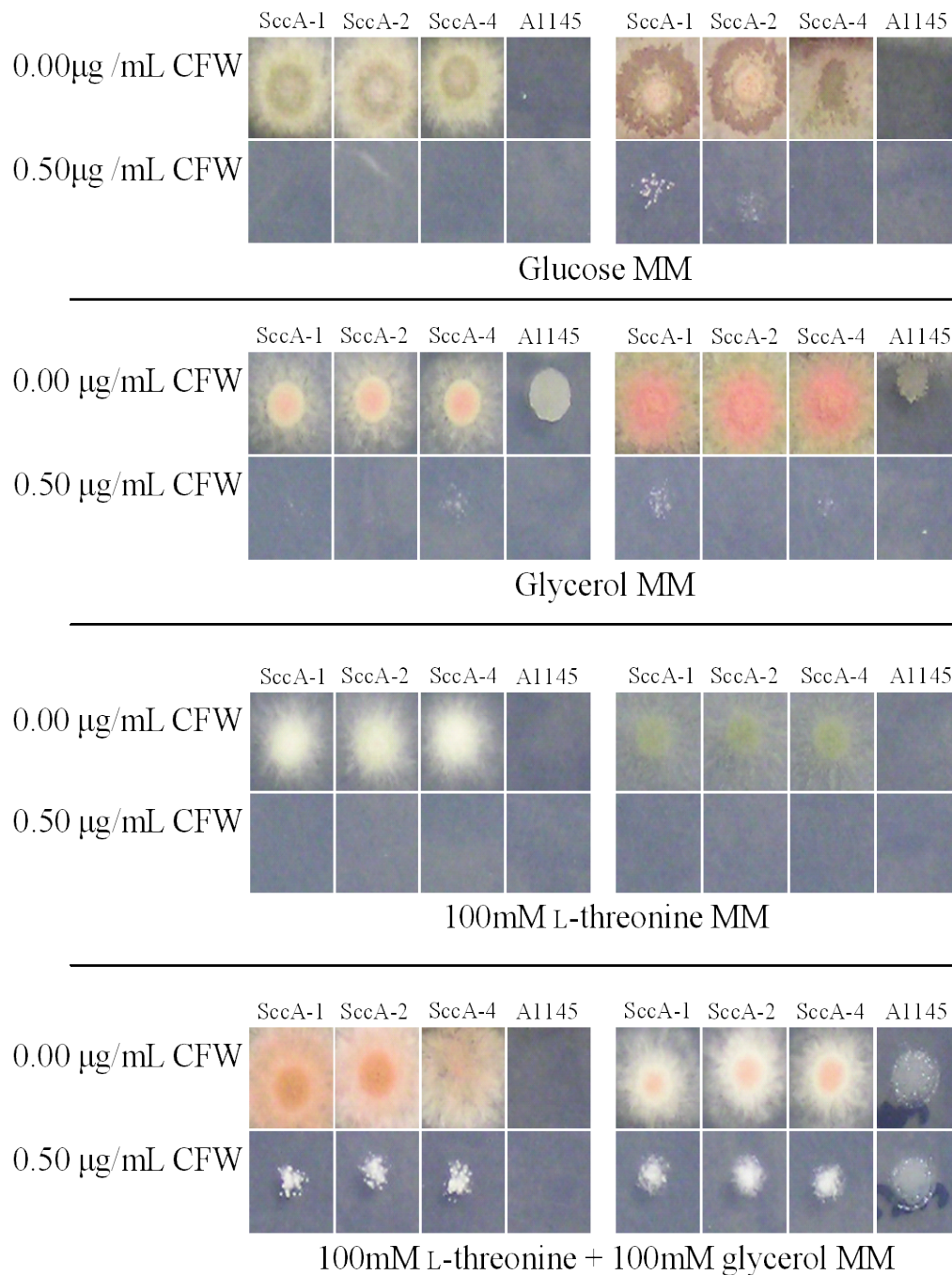
Figure 11. Effect of *SccA* induction on CFW sensitivity

These tests demonstrate that induction of *SccA* expression on 100 mM L-threonine + 100 mM glycerol facilitates vegetative growth. *SccA* induction could be mediating this decrease in CFW sensitivity, however in both tests the WT strain failed to grow. Strains grown 4d. @ 30 C. Each drop represents ca. 10,000 spores in 5 µL.

The $AlcA^P+SccA$ strain, designated SccA-3, showed an aberrant phenotype that was characterized by a strong resistance to CFW under all media conditions (**Figure 8, 10**). Thus, the SccA-3 strain represents a third phenotype, distinct from either phenotype observed in our previous work. This strain produces mycelial masses with a distinct white growth covering the sporulating bodies. This type of white colony appeared in all phenotype tests, and its vegetative growth was not inhibited by increasing levels of CFW. The SccA-3 strain was verified by PCR, but since this growth was not consistent with either the wild type *Al145* strain or the other $AlcA^P+SccA$ strains we have created, the SccA-3 strain was phased out of subsequent phenotype studies.

Osmotic Remediation Study – In addition to CFW hypersensitivity, strains with defects in wall structure are impaired for sporulation at 30°C, 42°C, or both temperatures, which is often osmotically remediable (Hill et al. 2006). During asexual development, wild type *A. nidulans* spores possess a green pigmentation, which causes colonies to appear dark green in color (Adams et al. 1998). In the absence of sporulation, underlying conidia structures give colonies a characteristic brown to bright red appearance.

Initial cultures of $AlcA^P+SccA$ strains on derepressing media (glycerol) at 30°C and 42°C produced consistent inhibition of sporulation in all strains. No such effect was observed on repressing media (glucose) at 30°C. However sporulation was inhibited at the elevated temperature on glucose containing media. To determine if this inhibition of sporulation was related to defects in cell wall integrity, osmotic strength was increased by supplementing each medium with 0.6 M KCl. The inhibition of sporulation was remediated on both media types regardless of temperature (**Figure 12**).

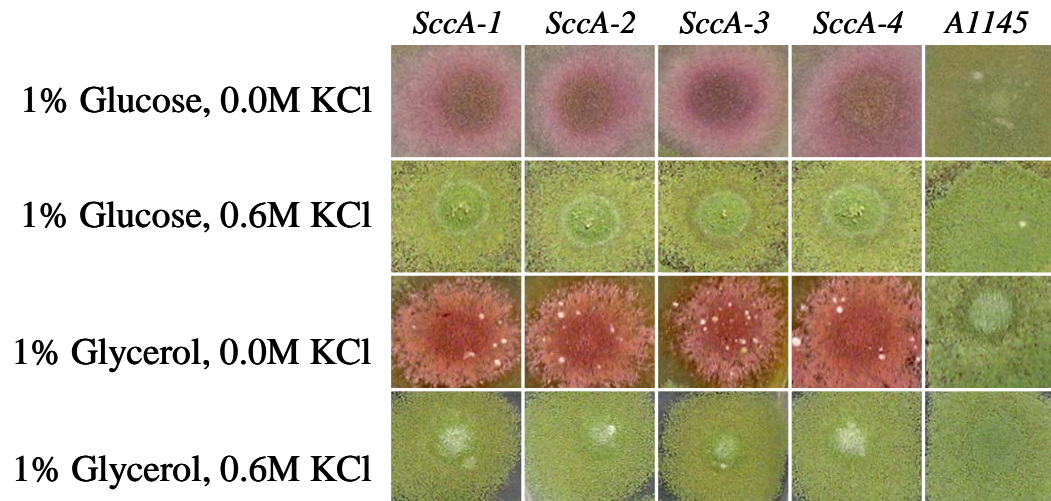
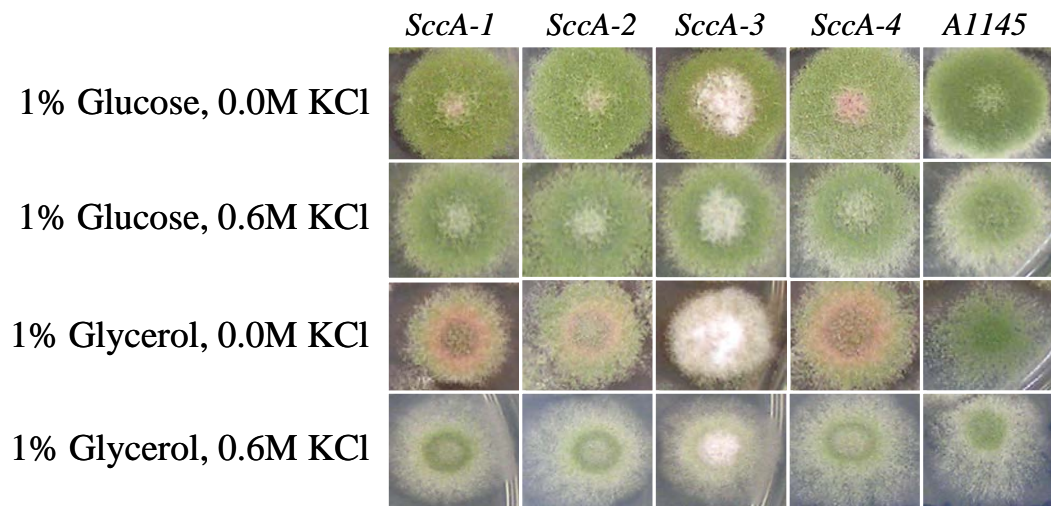
Figure 12. Osmotic remediation of sporulation defect

Effect of temperature and level of *SccA* expression on asexual sporulation in *AlcA^P+SccA* and WT (*A1145*) strains. *SccA* derepression (glycerol MM) inhibits asexual sporulation at both 30°C and 42°C in the absence of KCl. Inhibition of asexual sporulation is indicated by the distinct pink or red appearance of colonies. *SccA* repression (glucose) inhibits asexual sporulation only at the elevated temperature (42°C). Colonies were grown for 3 days on indicated MM medium. Each drop represents ca. 10,000 spores in 5 µL.

DISCUSSION

The involvement of the *SccA* gene in the *Aspergillus nidulans* cell wall integrity pathway was initially established by the observation that extra copies of this membrane sensor suppress the *calC2* mutation. Since initial attempts to delete the *SccA* gene have so far been unsuccessful, we have shifted to a promoter replacement strategy, employing the *AlcA^P* to regulate *SccA* expression. We have previously employed the *AlcA^P* system to regulate the expression of *PkcA*, the *A. nidulans* orthologue of protein kinase C, which is essential to fungus cell wall integrity and organism viability. *PkcA* heterokaryon deletion strains exhibit a ‘terminal phenotype’ where developmental progression halts during early conidia germination, producing malformed germ tubes that spontaneously lyse (Ichinomiya et al. 2006).

In our lab, we created an *AlcA^P* version of *PkcA* using the 512bp *AlcA^P*, and observed a similar but less severe phenotype under repressive conditions. In these strains, hyphal growth progresses well past germ tube formation but hyphae are frequently branched, swollen, and sometimes lyse (**Figure 13**). These findings are wholly in agreement with those of other researchers who have done *AlcA^P* replacement of this gene by a number of methods (Ichinomiya et al. 2006). Furthermore, this difference in phenotype suggests that glucose mediated repression of *PkcA* under the *AlcA^P*, allows some constitutive expression, thereby permitting a limited degree of development to occur. The ability of *AlcA^P+SccA* strains to successfully pass the initial stages of germ tube development and produce healthy sporulating colonies seems to indicate that the repressed expression of *SccA* under the *AlcA^P* is sufficient throughout development (**Figure 8**) However, our lack of success creating *SccA* knockout strains contradicts this

Figure 13. Effect of *PkcA* repression in *Aspergillus nidulans*

A.

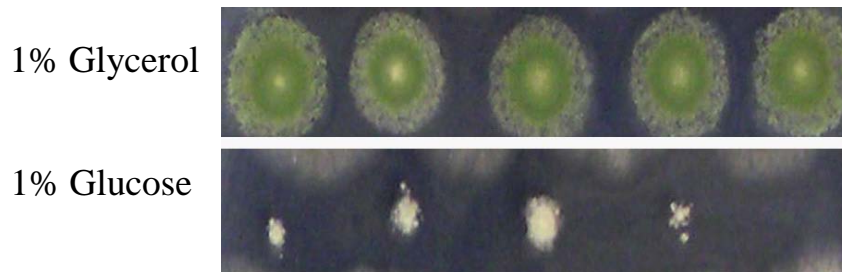

B.

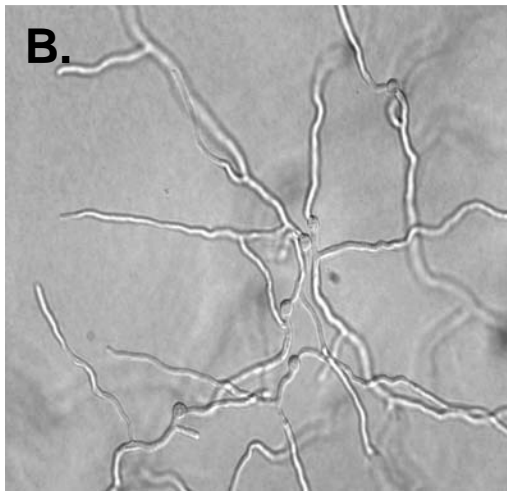

C.

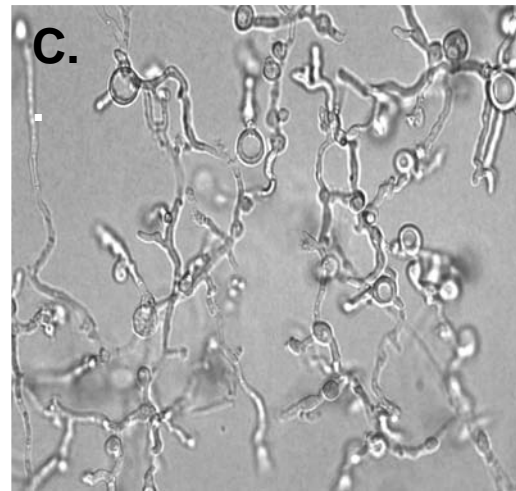

(A) Derepression of *PkcA* expression under the *AlcA^P* on glycerol containing media produces no morphological or asexual sporulation defects. However, glucose mediated repression of *PkcA* under the *AlcA^P* expression causes severe morphological defects. **(B)** Fungal hyphae showing normal branching and development on glycerol media. **(C)** Severe morphological defects are present in hyphae growing on glucose media. Swollen hyphal tips, erratic growth and cellular lysis contribute to the development of this phenotype.

evidence. Thus, further investigation into the level of *SccA* expression achieved during glucose mediated repression and the level of *SccA* expression required by developing fungal cells will be required to resolve this contradiction.

Two distinct patterns of vegetative growth were observed with *SccA* repression and *SccA* derepression. Glucose mediated repression produced colonies that exhibited robust hyphal development and thick mycelial masses (**Figure 10A**). Conversely, *AlcA^P+SccA* strains grew more slowly on glycerol containing media, producing colonies that did not develop as thick or robust mycelial masses (**Figure 10B**). However, this difference in vegetative growth was also manifested in the vegetative development of the *A1145* wild-type strain on glucose and glycerol media, respectively. It was concluded that this difference in vegetative growth could be primarily attributed to the fact that glycerol is not an ideal carbon source, as it cannot be metabolized as readily as glucose. This conclusion was supported by the observation that a medium supplemented with 2% glycerol does not affect the rate of vegetative growth relative to the standard 1% glucose containing medium (**Figure 9B, 9A**, respectively). The only unresolved deviation in vegetative growth concerned the aberrant colonies of the *SccA-3* strain, which formed large white mycelial masses regardless of media type or the presence or absence of CFW (**Figure 8, 10**).

In all other strains (*SccA-1*, *SccA-2* and *SccA-4*), *SccA* repression under the *AlcA^P* increased hypersensitivity to CFW relative to the wild-type strain (**Figure 10A**). This hypersensitive phenotype suggests that the low levels of *SccA* expression under glucose mediated *AlcA^P* repression is significantly less than the expression driven by the native *SccA* promoter. However, in the absence of CFW, *AlcA^P+SccA* strains exhibited no developmental abnormalities or sporulation defects.

Conversely, strong induction of *SccA* expression on media containing 100 mM L-threonine +100 mM glycerol produced the most robust vegetative growth in the presence of CFW. This observation could only be verified in relation to the growth of the *AlcA^P+SccA* strains on the other media because the WT strain did not successfully develop in these tests. However, in this comparison, the *AlcA^P+SccA* strains on 100 mM L-threonine, 1% glucose and 1% glycerol produced little or no vegetative growth in the presence of the same concentration of CFW (**Figure 11**). The observation that the 100 mM L-threonine medium failed to produce a significant amount of vegetative growth does contradict the idea that the addition of L-threonine to a glycerol containing media is responsible for the improved fungal growth in the presence of CFW. However, since neither L-threonine nor glycerol is as good a carbon source as glucose, we hypothesized that the addition these two alcohol catabolites might help to overcome this metabolic deficiency while also inducing the *AlcA^P* system.

Derepression of *SccA* expression under the *AlcA^P* decreased CFW sensitivity, which was demonstrated by the strains' ability to produce vegetative growth at all levels of CFW concentration (**Figure 10B**). However, in the absence of CFW, strains growing on glycerol containing media were unable to asexually sporulate. Inhibition of asexual sporulation is often a developmental defect that accompanies deficiencies in cell wall structure (Hill et al. 2006). The process of asexual sporulation is exceedingly complex, and involves several developmentally regulated genes including *wetA*, *brlA*, and *abaA*. Working in concert, these genes have been hypothesized to constitute the central regulatory pathway of conidiophore development and spore maturation, but this pathway has not been fully elucidated (Adams et al. 1998). Specifically, the *wetA* gene has been

implicated in the recruitment of certain cell wall components required for late-stage conidiophore development and in the regulation of spore development.

Thus, the inhibition of asexual sporulation observed with *SccA* derepression could be caused by the disruption of *wetA* signaling or a number of other pathways vital to sporulation (Adams et al. 1998). Although such a link could not be established in the present study, disruption of a developmental pathway involved in asexual sporulation could explain the observation that *SccA* induction both increases cell wall integrity and resistance to CFW, while also inhibiting asexual sporulation. The observation that the sporulation defect exhibited by strains grown on glycerol media at is osmotically remediable seems to suggest that the over expression of *SccA* initiates some change in the organization or structure of the cell wall. This conclusion was also supported by the observation that strains grown on either glucose containing media at 42°C also exhibited osmotically remediable sporulation defects (**Figure 12**).

In conclusion, this study details the successful use of *AlcA^P+SccA* strains to determine the specific phenotypes observed when *SccA* expression is varied and the fungal cell wall integrity pathway is activated by the presence of CFW. We have demonstrated that the *SccA* gene is involved in the *Aspergillus nidulans* cell wall integrity pathway, through the observations that *SccA* repression increases CFW hypersensitivity while *SccA* derepression decreases CFW hypersensitivity. These observations, coupled with the localization of *SccA* during fungal growth and development, suggest that this protein is an essential cellular sensor of wall stress in *Aspergillus nidulans*.

REFERENCES

1. Adams T, Margaret B, Timberlake W. 1988. *brlA* is necessary and sufficient to direct conidiophore development in *Aspergillus nidulans*. *Cell*. 54: 353-362.
2. Adams T, Timberlake W. 1990. Developmental repression of growth and gene expression in *Aspergillus*. *Proceedings of the National Academy of Sciences USA*. 87: 5405-5409.
3. Adams T, Wieser J, Yu J-H. 1998. Asexual sporulation in *Aspergillus nidulans*. *Microbiology and Molecular Biology Reviews*. 62: 35-54.
4. Carnero E, Ribas J-C, Garcia B, et al. 2000. *Schizosaccharomyces pombe ehs1p* is involved in maintaining cell wall integrity and in calcium intake. *Molecular & General Genetics*. 264:173-183.
5. Denning D. 2000. Early diagnosis of invasive aspergillosis. *Lancet*. 355: 423.
6. Felenbok B. 1991. The ethanol utilization regulon of *Aspergillus nidulans*: the *alcA-alcR* system as a tool for the expression of recombinant proteins. *Journal of Biotechnology*. 17: 11-18.
7. Felenbok B, Flipphi M, Nikolaev I. 2001. Ethanol catabolism in *Aspergillus nidulans*: a model system for studying gene regulation. *Progress in Nucleic Acid Research and Molecular Biology*. 69: 149-204.
8. Fillinger S, Panozzo C, Mathieu M, et al. 1995. The basal level of transcription of the *alc* genes in the ethanol regulon in *Aspergillus nidulans* is controlled both by the specific transactivator AlcR and the general catabolite repressor CreA. *FEBS Letters*. 368: 547-550.
9. Florl C, Kofler G, Kropshofer G, et al. 1998. In-vitro susceptibility to amphotericin B is a reliable predictor of clinical outcome in invasive aspergillosis. *Journal of Antimicrobial Chemotherapy*. 42: 497-502.
10. Hill T, Kafer E. 2001. Improved protocols for *Aspergillus* minimal medium: trace element and minimal media salt stock solutions. *Fungal Genetics Newsletter*. 48: 20-21.
11. Hill T, Loprete D, Momany M, et al. 2006. Isolation of cell wall strains in *Aspergillus nidulans* by screening for hypersensitivity to Calcofluor White. *Mycologia*. 98: 399-409.
12. Ichinomiya M, Uchida H, Koshi Y. 2007. A protein kinase C-encoding gene *PkcA* is essential to the viability of the filamentous fungus *Aspergillus nidulans*. *Bioscience, Biotechnology and Biochemistry*. 71: 2787-2799.

13. Kafer E. 1977. Meiotic and mitotic recombination in *Aspergillus* and its chromosomal aberrations. *Advanced Genetics*. 19: 33-131.
14. Kriangkripiat T, Momany M. 2009. *Aspergillus nidulans* protein O-mannosyltransferases play roles in cell wall integrity and developmental patterning. *Eukaryotic Cell*. 8: 1475-1485.
15. Kulmburg P, Judewicz N, Mathieu M, et al. 1992. Specific binding sites for the activator protein AlcR in the *alcA* promoter of the ethanol regulon of *Aspergillus nidulans*. *Journal of Biological Chemistry*. 267: 21146-21153.
16. Latgé J-P. 1999. *Aspergillus fumigatus* and aspergillosis. *Clinical Microbiology Reviews*. 12: 310-350.
17. Latgé J-P. 2001. The pathobiology of *Aspergillus fumigatus*. *Trends in Microbiology*. 9: 382-390.
18. Lesage G, Bussey H. 2006. Cell wall assembly in *Saccharomyces cerevisiae*. *Microbiology and Molecular Biology Review*. 70: 317-343.
19. Levin D. 2005. Cell wall integrity signaling in *Saccharomyces cerevisiae*. *Microbiology and Molecular Biology Reviews*. 69: 262-291.
20. Lussier M, White A-M, Sheraton J, et al. 1997. Large scale identification of genes involved in cell surface biosynthesis and architecture in *Saccharomyces cerevisiae*. *Genetics*. 147:435-450.
21. Maertens J, Boogaerts M. 2000. Fungal cell wall inhibitors: emphasis on clinical aspects. *Current Pharmaceutical Design*. 6: 225-239.
22. Marhoul J, Adams T. 1995. Identification of developmental regulatory genes in *Aspergillus nidulans* by overexpression. *Genetics*. 139: 537-547.
23. Mirabito P, Adams T, Timberlake W. 1989. Interactions of three sequentially expressed genes control temporal and spacial specificity in *Aspergillus* development. *Cell*. 57: 859-868.
24. Nayak T, Szewczyk E, Oakley E, et al. 2006. A versatile and efficient gene-targeting system for *Aspergillus nidulans*. *Genetics*. 172: 1557-1566.
25. Ostrosky-Zeichner L, Marr K, Rex J, et al. 2003. Amphotericin B: time for a new gold standard. *Reviews of Anti-infective Agents*. 37: 415-426.
26. Ram AFJ, Wolters A, Ten Hoopen R, et al. 1994. A new approach for isolating cell wall strains in *Saccharomyces cerevisiae* by screening for hypersensitivity to Calcofluor White. *Yeast*. 10:1019-1030.

27. Romero B, Turner G, Olivas I, et al. 2003. The *Aspergillus nidulans alcA* promoter drives tightly regulated conditional gene expression in *Aspergillus fumigatus* permitting validation of essential genes in this human pathogen. *Fungal Genetics & Biology*. 40: 103-114.
28. Strahl-Bolsinger S, Gentzsch M, Tanner W. 1999. Protein *O*-mannosylation. *Biochimica et Biophysica Acta*. 1426: 297-307.
29. Szewczyk E, Nayak T, Oakley E, et al. 2007 Fusion PCR and gene targeting in *Aspergillus nidulans*. *Nature Protocols*. 6: 3111-3122.
30. Teepe A, Loprete D, He Z, et al. 2007. The protein kinase C orthologue PkcA plays a role in cell wall integrity and polarized cell growth in *Aspergillus nidulans*. *Fungal Genetics and Biology*. 44: 554-562.
31. Verna J, Lodder A, Lee K, et al. 1997. A family of genes required for maintenance of cell wall integrity and for the stress response in *Saccharomyces cerevisiae*. *Proceedings of the National Academy of Sciences USA*. 94: 13804-13809.
32. Wald A, Leisenring W, van Burik J-A, et al. 1997. Epidemiology of *Aspergillus* infections in a large cohort of patients undergoing bone marrow transplantation. *Journal of Infectious Diseases*. 175: 1459-1466.
33. Waring R, May G, Morris N. 1989. Characterization of an inducible expression system in *Aspergillus nidulans* using *alcA* and tubulin-coding genes. *Gene*. 79: 119-130.
34. Wingard J, White M, Anaissie E, et al. 2000. A Randomized, double-blind comparative trial evaluating the safety of liposomal amphotericin B versus amphotericin B lipid complex in the empirical treatment of febrile neutropenia. *Clinical Infectious Diseases*. 31: 1155-1163.
35. Yang L, Ukil L, Osmani A, et al. 2004. Rapid production of gene replacement constructs and generation of a green fluorescent protein-tagged centromeric marker in *Aspergillus nidulans*. *Eukaryotic Cell*. 3: 1359-1362.
36. Yelton, M, Hamer J, Timberlake W. 1984. Transformation of *Aspergillus nidulans* by using a *trpC* plasmid. *Proceeding of the National Academy of Sciences USA*. 81: 1470-1474.
37. Yu J-H, Mah J-H, Seo J-A. 2006. Growth and developmental control in the model and pathogenic Aspergilli. *Eukaryotic Cell*. 5: 1577-1584.